

## THERE'S AN ULLRICH ALUMINIUM BRANCH NEAR YOU

### NEW SOUTH WALES

Sydney General Enquiries:  
185-187 Woodpark Road  
Smithfield, NSW 2164  
+61 (2) 8787 7400

Sydney Fabrication:  
185-187 Woodpark Road  
Smithfield, NSW 2164  
+61 (2) 8787 7468

Sydney South:  
15 Blackmore Road  
Smeaton Grange, NSW 2567  
+61 (2) 4646 2200

Kurri Kurri:  
HEZ Extrusion Plant  
Lot 1, Bromage Road  
HEZ Industrial Estate  
Kurri Kurri, NSW 2327  
+61 (2) 4937 4700

Newcastle:  
6 Steel River Boulevard  
Mayfield West, NSW 2304  
+61 (2) 4949 2600

Bathurst:  
10 Bradwardine Road  
Robin Hill, NSW 2795  
+61 (2) 6339 8900

Coffs Harbour:  
13 Cook Drive  
Coffs Harbour, NSW 2450  
+61 (2) 6690 2400

Albury-Wodonga  
28 Fallon Street  
Albury, NSW 2640  
+61 (2) 6049 9800

### SOUTH EAST QUEENSLAND

Brisbane:  
20 Ron Boyle Crescent  
Carole Park, QLD 4300  
+61 (7) 3718 1400

Banyo:  
40 Buchanan Road  
Banyo, QLD 4014  
+61 (7) 3335 6700

Caloundra:  
37 Enterprise Street  
Caloundra, QLD 4551  
+61 (7) 5390 7600

Gold Coast:  
24 Township Drive  
West Burleigh, QLD 4219  
+61 (7) 5586 1500

### QUEENSLAND

Cairns:  
16 Spoto Street  
Woree, QLD 4868  
+61 (7) 4252 3200

Townsville:  
5 Whitehouse Street  
Garbutt, QLD 4814  
+61 (7) 4720 7100

Mackay:  
105-111 Maggilo drive  
Paget, QLD 4740  
+61 (7) 4952 4157

Rockhampton:  
103 Stanley Street  
Rockhampton, QLD 4700  
+61 (7) 4923 8600

Wide Bay:  
48B Lower Mountain Road  
Dundowran, QLD 4655  
+61 (7) 4196 9000

### NORTHERN TERRITORY

Darwin:  
114 Reichardt Road  
Winnellie, NT 0820  
+61 (8) 7929 8400

### WESTERN AUSTRALIA

Perth:  
17 King Street  
Bayswater, WA 6053  
+61 (8) 9473 4700

Bunbury:  
33 Clifford Street  
Davenport, TAS 6230  
+61 (8) 9725 9900

### TASMANIA

Launceston:  
86 Invermay Road  
Launceston, TAS 7250  
+61 (3) 6327 8600

Hobart:  
123 Albert Rd  
Moonah, TAS 7009  
+61 (3) 6278 0000

### VICTORIA

Melbourne:  
893 Princes Highway  
Springvale, VIC 3171  
+61 (3) 9567 7200

### SOUTH AUSTRALIA

Adelaide:  
57 Diagonal Road  
Pooraka, SA 5095  
+61 (8) 8300 2500

### ACT REGION

Canberra:  
12 Sawmill Circuit  
Hume, ACT 2620  
+61 (2) 6243 9700



# ULLTRA SIGN

➤ FLAT LIGHTWEIGHT COMPOSITE PANELS



## GALLERY OF ALUMINIUM COMPOSITE PANEL SYSTEMS



Aluminium composite panels are widely used for display, signage, as signboards and for advertising panels.



# TECHNICAL INFORMATION



Easily maintained, flat, lightweight panels with a surface finish to suit precise printing.

With the digital age more people are embracing the idea that creative work environment helps stimulate minds and inspire innovation.

Wall graphics are the fast and easy way to transform your work environment.

Available in a wide range of standard colours, Project colours can be ordered on request.

Please note: Reference colours have been matched as closely as possible.

We recommend that you use production line prepared samples for final colour selection or approval.

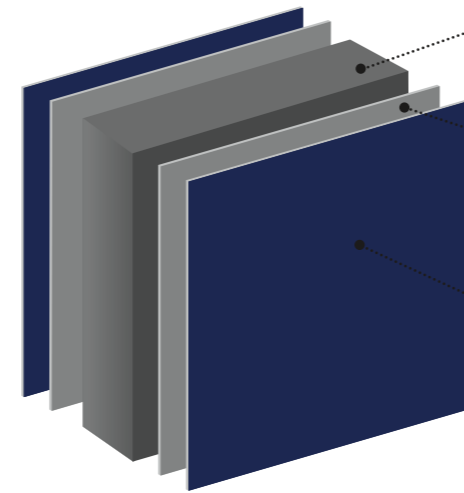

Core Material
> Black Polyethylene
> Non-combustible mineral
> Fluted PP
> Honeycomb & Spherical aluminium
Surface Treatment Options
Paint types - Polyester, PVDF, Nano-PVDF, Wood Grain, etc.
Available Surface Finishes
> Standard aluminium
> Brush (Anodised)
> Mirror (Anodised)
> Powder coated (Gloss or Matte)

Ulltra Panel sign grade is a sandwiched panel consisting of low-density polyethylene core bonded to two thin coil-coated aluminium sheets. The core is typically black.

Ulltra Panel Fire Retardant is composed of non-combustible mineral core with a small amount of low-density polyethylene sandwiched between two aluminium sheets. The core is white or grey.

Topside of ACM is coated with different kinds of paint such as polyester, PVDF, Nano-PVDF, etc.

## ULLTRA PANEL FABRICATION SERVICE

Ullrich Aluminium can provide a fabrication service direct ex-mill, on offer is an array of machining and fabrication services, these in accordance to customer request and technical drawings.

Ulltra Panel fabrication services reduce labour content and provide a ready made and installable end product to the customer and assists with the onsite construction convenience.

The fabrication services include:

- > Cutting / punching / stamping / drilling / folding
- > Shaping / forming / assembly
- > Customised fabrication according to CAD drawing

Part Number	Part Description	Panel Thickness	Panel Width	Panel Length	Finish Colour
ACP3.012202440	ALUMINIUM COMPOSITE PANEL ULLTRASIGN	3mm	1220mm	2400mm	Contact your local Ullrich Aluminium Branch for Colour Options
ACP3.012203000		3mm	1220mm	3000mm	
ACP3.012203600		3mm	1220mm	3600mm	
ACP4.012202400		4mm	1220mm	2400mm	
ACP4.012203000		4mm	1220mm	3000mm	
ACP4.012203600		4mm	1220mm	3600mm	
ACP4.015002400		4mm	1500mm	2400mm	
ACP4.015003000		4mm	1500mm	3000mm	
ACP4.015003600		4mm	1500mm	3600mm	
ACP4.015004000		4mm	1500mm	4000mm	
ACP4.020004000		4mm	2000mm	4000mm	

# PANEL SIZES & PROCESSING DETAILS



SAWING

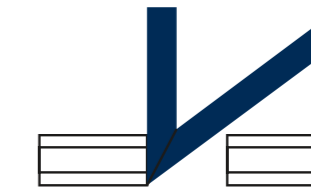

CUTTING

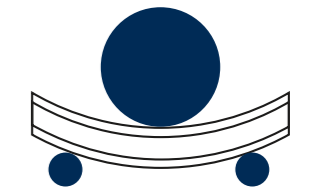

BENDING

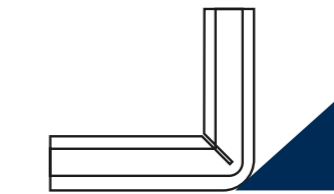

FOLDING



DRILLING

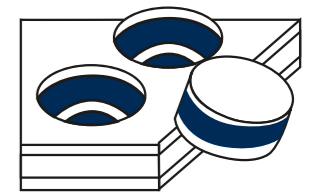

PUNCHING

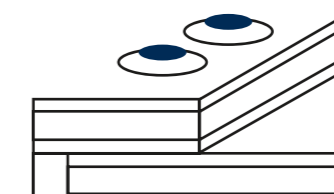

RIVETING

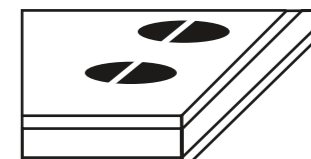

SCREWING



WELDING



GLUEING



DECORATIVE WORK

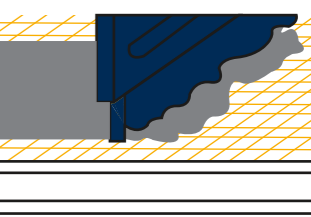

SCREEN PRINTING



DIGITAL PRINTING

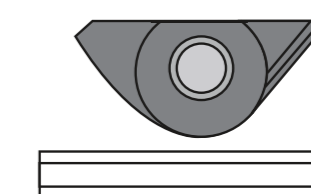
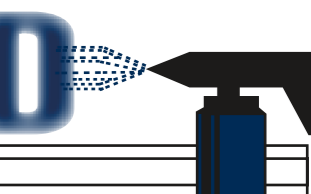

PHOTO MOUNTING



SPRAYING